

maars LIVING WALLS®

الجريد
AL JURAID



M923.™

The wall is yours





M923.™

The wall is yours

“The whole point of an open office is to keep it open. But a truly open office comes with a high price. Workers get distracted, the space can seem cavernous and impersonal, and the workplace becomes a fishbowl. Striking a balance between open, collaborative spaces and the exhausting noise and lack of privacy that ill-designed open spaces create is a difficult task. The right tools certainly help. That’s where the M923. comes into its own.”

Specifications

Maximum wall height with extended profile	4.000 mm (13 ft 1.5")
Maximum wall height with standard profile	3.420 mm (11 ft 2")
Module width	1.230 mm (4 ft 0.44")
Vertical placement points	375 mm (1 ft 2.8")
Frame capacity	maximum of 4 panels high per module back to back
Half height	minimum of 2 panels high and maximum of 2 modules wide

Grid

- Vertical studs packaged and priced in quantities of 3 pieces per bundle
- Cross profiles packaged and priced in quantities of 3 pieces per bundle

Materials

Grid	Steel
Panels	Sheetmetal with coating and/or special finish (cork, moss, marker board, textile and perforated panel) and black steel backing



Mobile and flexible

- You determine the look and layout
- Colorful, natural, and functional panels
- Easy to adjust by hand
- Designed with ergonomics in mind



Framework

- Available in various configurations
- Can be used in any room up to maximum profile height
- Option for straight wall, L-wall or T-wall
- Height-adjustable

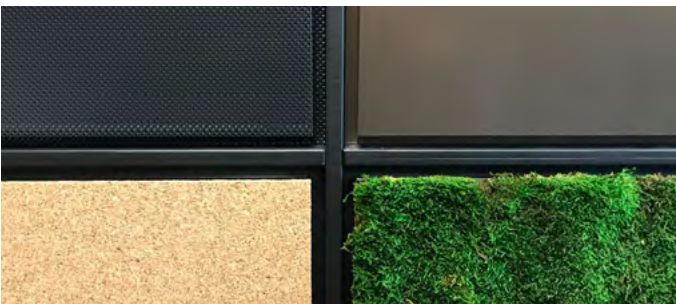
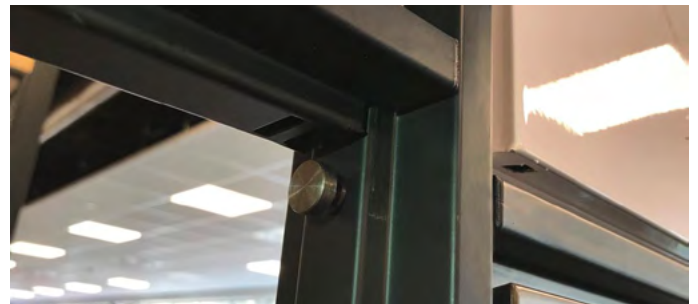

Unique possibilities

- Durable and environmentally friendly
- Endless configurations possible
- Framework can easily be customized
- For offices, shops, schools, flexible workspaces and restaurants

Installation

- Easy to move
- Install without drilling by using leveling feet
- Several solutions for attachment to the ceiling
- Solutions for the most commonly used ceiling and floor situations

Attachment to the ceiling:

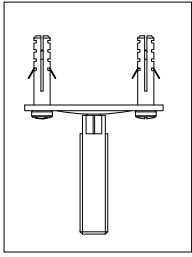

Screw fixing

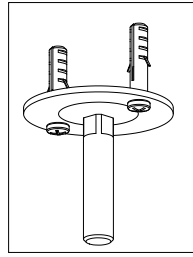

Screw fixing (3D)

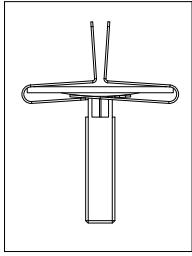

Ceiling grid system

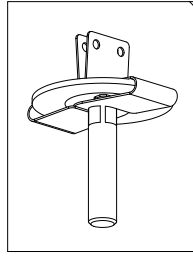

Ceiling grid system (3D)

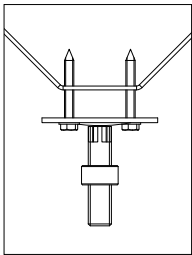

Seismic

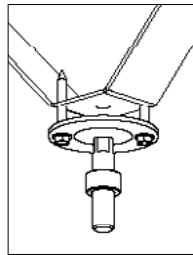

Seismic (3D)

Attachment to the floor:

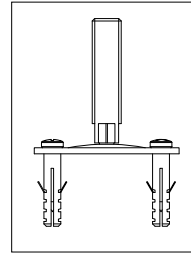

Screw fixing

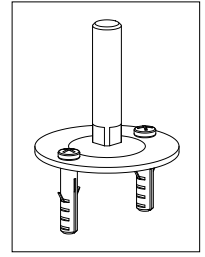

Screw fixing (3D)

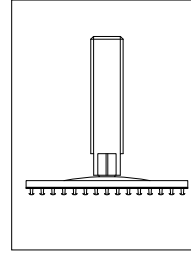

Carpet gripper

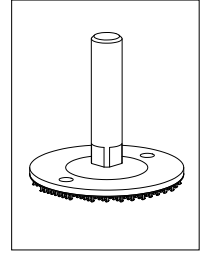

Carpet gripper (3D)

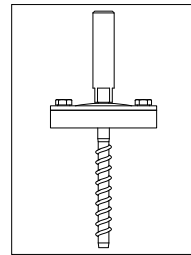

Seismic

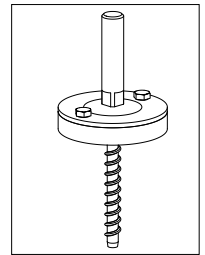

Seismic (3D)



Profile with floor attachment

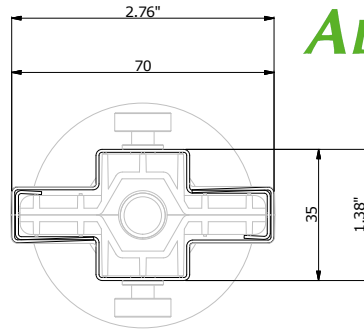
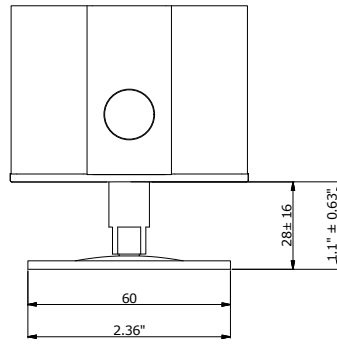

Panel finishes

Frame finishes (powder coated):

Backing panels:

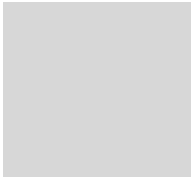

Light gray

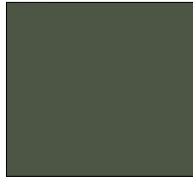

Green gray



Dark bronze



Black matte



Black matte

Panel finishes (powder coated):

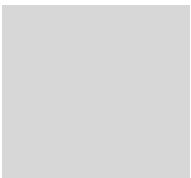

Light gray

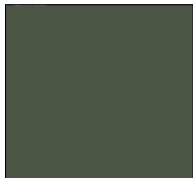

Green gray

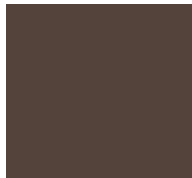

Dark bronze



Ocean blue

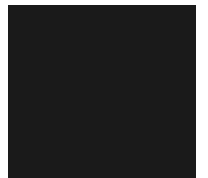

Black matte

Textiles:



Messenger 046

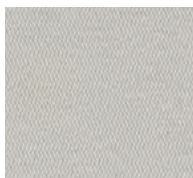

Messenger 079

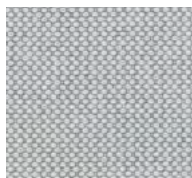

Merit 001

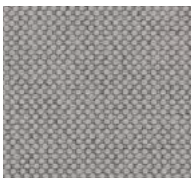

Merit 043

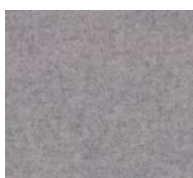

Divina MD 713

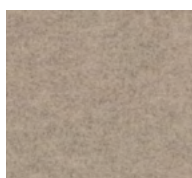

Divina MD 213



Special finishes:



Marker board

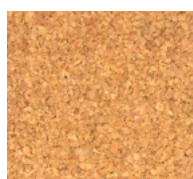

Cork

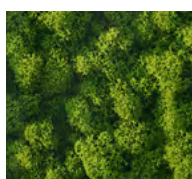

Reindeermoss

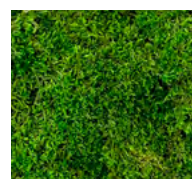

Flat moss



Perforated
(available in all five powder coating colours)

Product name	ASTM E 84	EN 13501-1
Textile Messenger	Class A	-
Textile Merit	Class A	-
Textile Divina MD	Class A	C-s1,d0
Cork	Class B	-

Seismic Engineering Report for Anchorage and Stability
Review

Technical details

Vertical studs and cross profiles

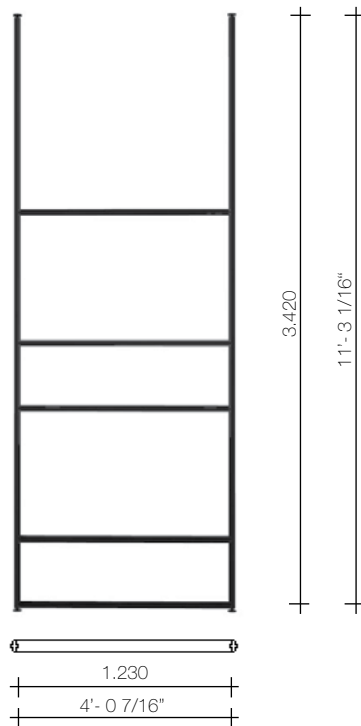

Half height

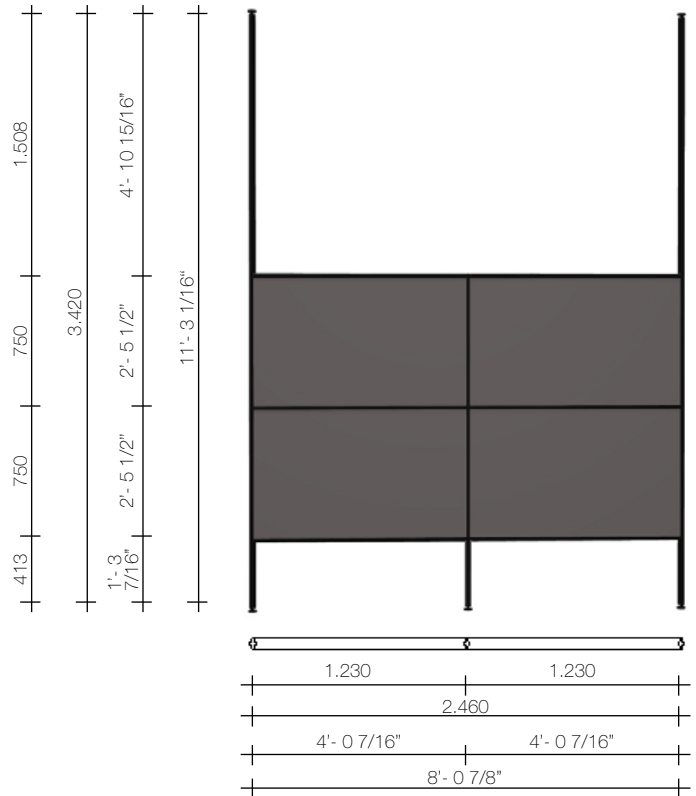

M923. panel options triple module

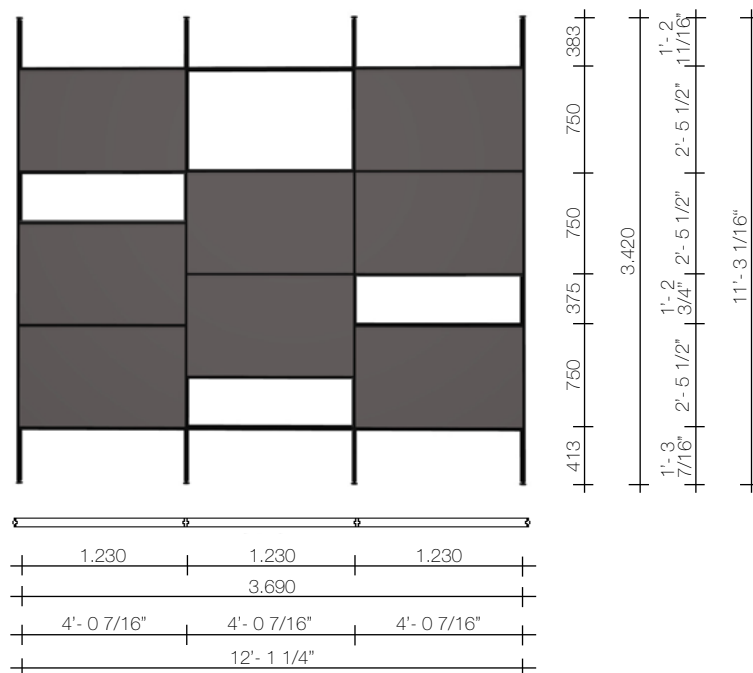

Corner 90°

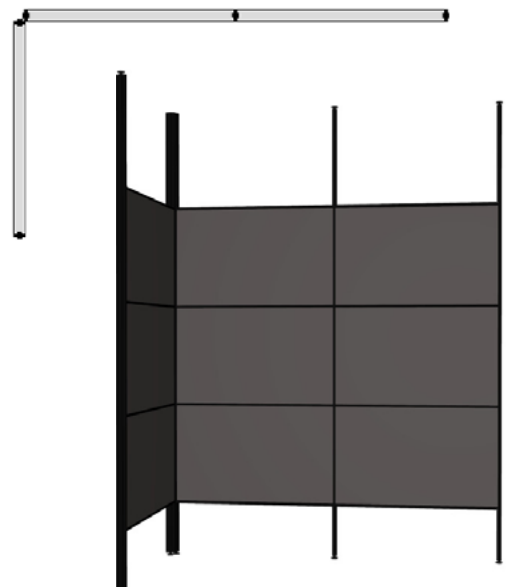

Seismic solutions

For seismic zones, M923. has restrictions for the configurations. Underneath an overview of those restrictions. Notice also that the standard seismic solution for M923. via Maars will be expected to be available per May 2020.

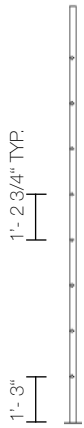

Typical placement spacing



Single module configuration

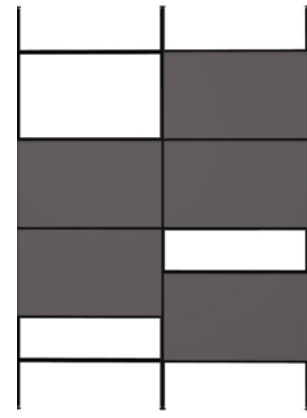

Double module configuration

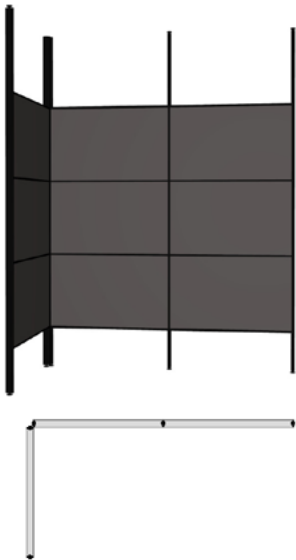

Corner module configuration

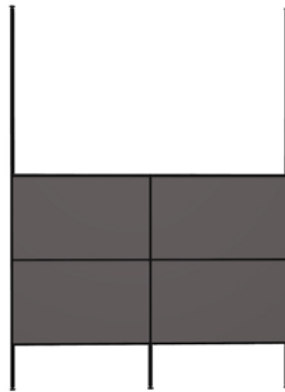

Double module half height configuration

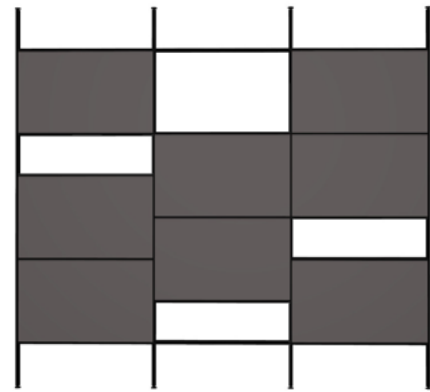

Triple module configuration

Module specifications

Minimum panels per module = 2 single panels

Maximum panels per module = 4 panel pairs (back-to-back)/8 single panels

Maximum frame height:

- all configurations with 4 single panels max. frame height = 13' - 1 1/2"
 - with 2 or 3 panel pairs per module in all configurations max. frame height = 13' - 1 1/2"
- with 4 panel pairs per module:
- single module configuration max. frame height = 13' - 1 1/2"
 - double/triple module configurations max. frame height = 11' - 10"
 - corner module configuration max. frame height = 12' - 9"



This simple-to-use, hackable product is designed for workers to create their own privacy in open-office structures and personalize their own workplaces.

M923. is a modular panel system. It creates a flexible and versatile system. The concept combines modern wall decoration, functional office furniture and movable walls.

The result is a complete system that provides privacy in what Maars calls 'an aesthetic and ergonomically responsible manner'.



The panels are available in different colors and materials (including moss, cork, absorption panels, marker boards and textiles). Users can easily change the panels and design the wall themselves. Because the panels are easy to change, it's possible to adjust the appearance of a room very quickly and inexpensively.



Application and installation M923.

The M923 is a relocatable floor-to-ceiling, non load-bearing, non-fire-resistant, interior screening system. It is not a wall partition system and has no sound isolating capacities, nor can it support a door or other wall elements outside the design of the system itself. This product is not designed to hang objects on, other than the Maars supplied panels and accessories. Use of this system to support furniture loads, and in corporation with door components or electrical wiring have not been evaluated and are beyond the scope of this product. The product is designed for interior purposes only. It is not safe to play with or climb in. The product is designed to be installed between stable floor and ceiling constructions of a building*. For stability reasons the product is limited in length up to 5 modules.

The product consists of a framework made of steel formed profiles. The profiles are attached with inner adaptors to constructive feet that connect the framework to the ceiling deck or floor. Within the framework, infills can be mounted on both sides of the framework. This system, once installed according to the instructions Maars has given, will comply with the 5psf transverse load requirements specified in the IBC 2018 section 1607.15. Use a minimum of 3 horizontal profiles per module to ensure stability. Also, always apply 4 safety clips per panel to secure the panel in the framework.

The steel panels are supplied with a backboard finish that is tested according to ASTM E84. The finishes (cork, moss and textiles) of the infill panels all have certificates according to ASTM E84, except for the flat moss finish. Note that the certificates of the finishes have different classes to ASTM E84. End user is responsible to comply to the IBC and local building codes.

A Review Report is available to provide the Structural Engineer of Record (SEOR) with seismic bracing and/or anchorage recommendations for this M923 screens with a max. height of 11'-4" installed at locations with the highest seismicity. The report indicates anchoring solutions for common construction elements. These calculations are based on the 2019 California Building Code (CBC), the 2018 International IBC and to the 2016 Minimum Design Loads for Buildings and Other Structures (ASCE 7).

Installation recommendations to different floor and ceiling situations and the measures that need to be taken in order to install the product properly:

Ceiling	Floor	Fixings
Concrete deck	Concrete deck	Fix feet to ceiling and floor deck
Concrete deck	Carpet over concrete deck	Fix feet to ceiling and floor deck
Concrete deck	Carpet over concrete deck with heated flooring	Fix feet to ceiling deck and put carpet gripper on floor. Check for sufficient pressure to keep M923 framing stable and carpet gripper in place
Exposed grid	Concrete deck	Stabilize grid to SEOR instructions and fix to grid + fix feet to floor
Exposed grid	Carpet over concrete deck	Stabilize grid to SEOR instructions and fix to grid + fix feet to floor
Exposed grid	Carpet over concrete deck with heated flooring	Stabilize grid to SEOR instructions and fix to grid + put carpet gripper on floor. Check for sufficient pressure to keep M923 framing stable and carpet gripper in place

**When a suspended ceiling system is used to support the product, the ceiling grid must be adequately braced to resist lateral loads imposed by the system and be approved by a building code official. Connectors used to connect the wall system to supporting members must be adequate to resist post loads and must be approved by a building code official. Maars delivers fixings to be used in wood or sheet metal, which are not applicable for all types of ceilings as mentioned in the overview below.*

Disclaimer flat moss

Moss does not need any maintenance. Moss has a natural fragrance. This fragrance gradually diminishes and is absolutely harmless. Moss may discolour in due course under the influence of light, such as sunlight. As there may be colour differences in different boxes and batches of moss, please mix the batches (i.e. boxes) when using the moss. Do not rinse the moss with water or any other liquids. The moss is only suited to indoor use. Do not place it outdoors. The moss may release some pigments. This effect can be cleaned off with soap and water. In conditions of low relative humidity (less than 30%), the moss can be slightly drier temporarily. As soon as the humidity level increases, the moss will become soft again.

Disclaimer reindeer moss

To maintain the quality for a long time, the following conditions must be fulfilled to ensure the freshness and softness of the reindeer moss panel: use indoors only, ensure a relative humidity rate in the environment where it is installed of 40%. Do not water or spray the moss wall. Do not expose to direct sunrays. Do not walk on it. Colour variations are not a flaw but a characteristic due to the naturalness of the product.

M923. app



Users and architects can discover the possibilities of M923. with an augmented reality app that's available on the App Store and on Google Play. The AR app allows a customized M923. wall with all available panels to be placed virtually in a room. The self-assembled wall with accessories can then easily be forwarded to order with all selected options. The ordering process is done through Maars 4D. Get yours now!



Newtonweg 1, PO Box 1000
3840 BA Harderwijk
The Netherlands

T +31 (0)341 46 52 11
info@maars.nl
www.maarslivingwalls.com

Designed in collaboration with Gensler as a product design consultant

Patent pending



Follow us online



Discover the M923. Download the AR-app via the App-store or Google Play.